

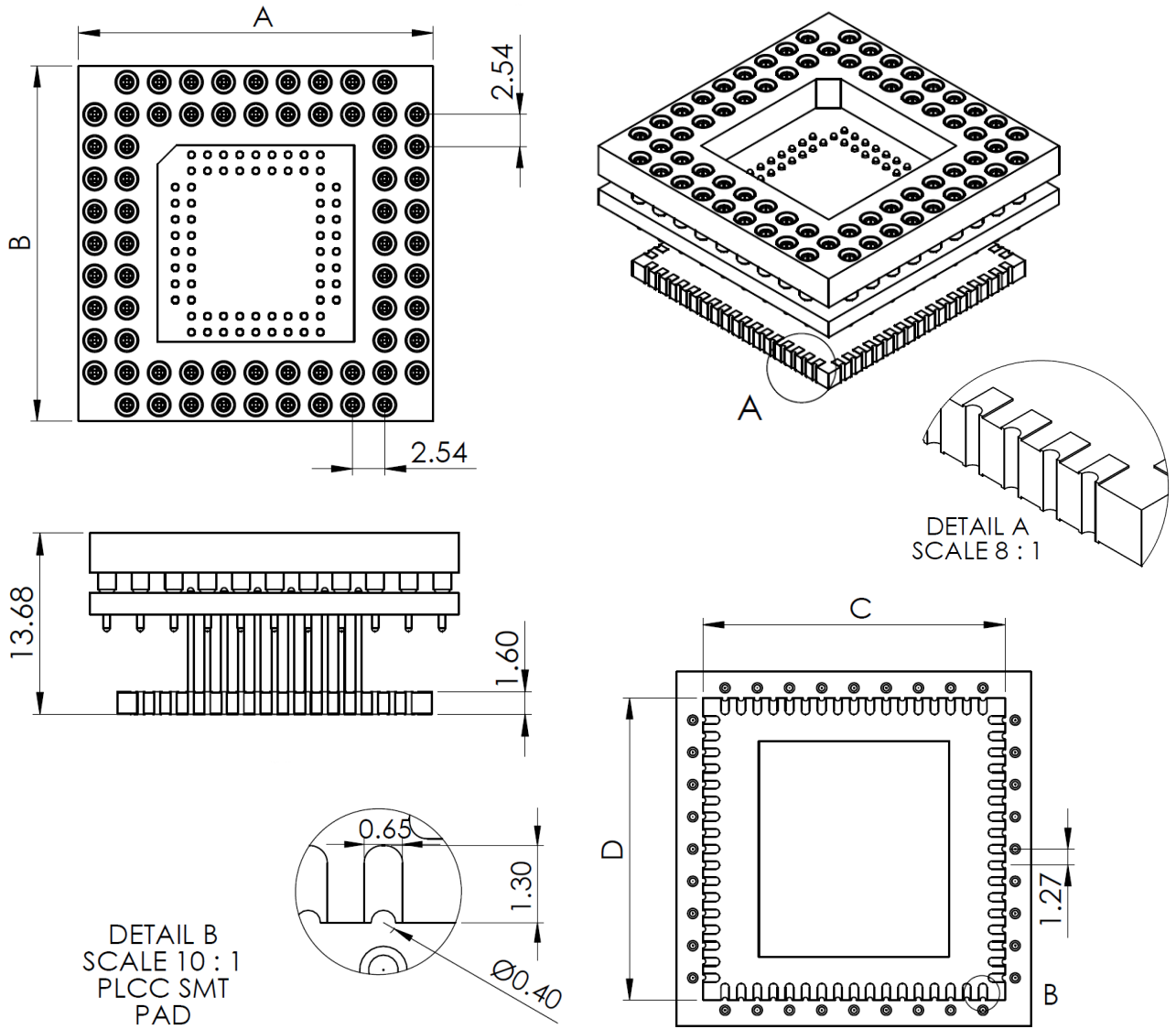

WA0xx127SDRC PGA to PLCC Adapter Series



Part Number	Top Package	Bottom Package	'A'	'B'	'C'	'D'
WA020127SDRC	PGA20	PLCC20	12.7	12.7	8.30	8.30
WA028127SDRC	PGA28	PLCC28	15.24	15.24	10.90	10.90
WA032127SDRC	PGA32	PLCC32	15.24	17.78	10.90	13.50
WA044127SDRC	PGA44	PLCC44	20.32	20.32	15.90	15.90
WA052127SDRC	PGA52	PLCC52	22.86	22.86	18.50	18.50
WA068127SDRC	PGA68	PLCC68	27.94	27.94	23.80	23.80
WA084127SDRC	PGA84	PLCC84	33.02	33.02	28.70	28.70



WA0xx127SDRC PGA to PLCC Adapter Series

PGA Footprints

20 PGA

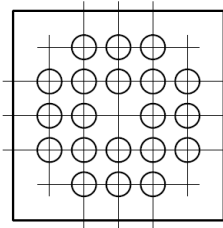

28 PGA

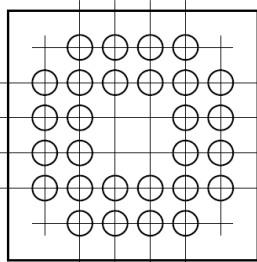

32 PGA

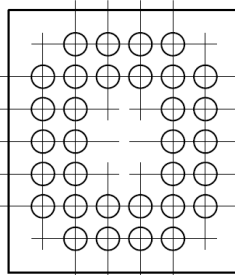

44 PGA

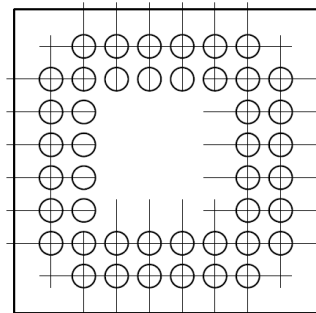

52 PGA

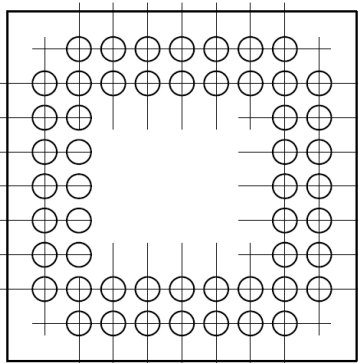

68 PGA

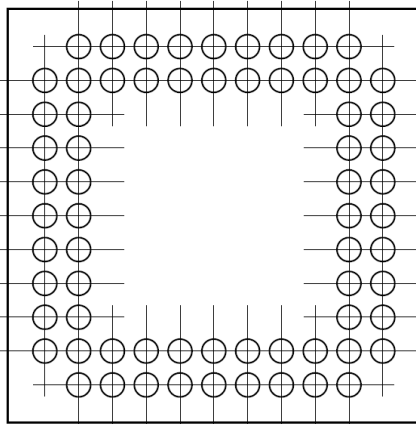

84 PGA

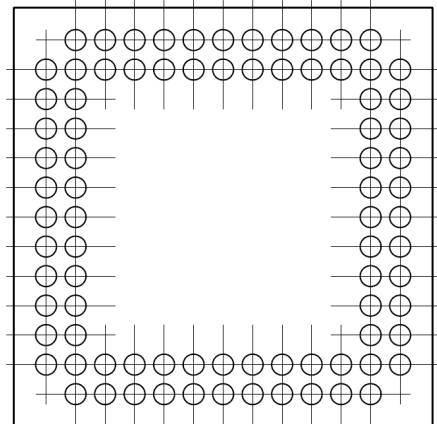

Not to scale. All dimensions in millimeters, unless otherwise specified.
Specifications may be subject to alteration without prior notice. Please contact factory for confirmation.



Solutions to Component Leadtime and Obsolescence

Also available from Winslow Adaptics are cost effective, time saving solutions to test, obsolescence, supply problems and upgrades. OEMs can upgrade equipment with custom Adaptics utilising additional logic, often saving considerable cost and time on re-design. If lead-time becomes an issue contact us for a suitable package converter. We specialise in conversion of all package lead-frames. For further information please contact your nearest sales office